

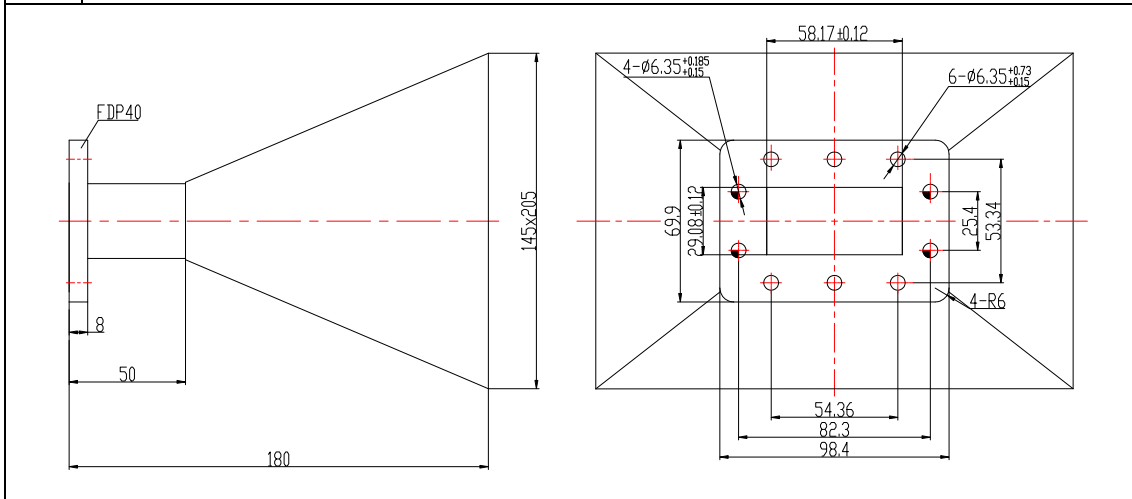

Standard Gain Horn Antenna

Part No: HD-40SGAH15

1.0	Mechanical Specifications	
1.1	Waveguide type	WR229
1.2	Flange type	FDP40 (Cover)
1.3	Material	Aluminum
1.4	Inside finish	Chromate conversion
1.5	Outside finish	Anticorrosion grey paint
2.0	Electrical Specifications	
2.1	Frequency Range	3.22-4.9 GHz
2.2	VSWR (Max)	1.5
2.3	Gain (Avg)	15 dB
2.4	3 dB Beamwidth	30°
3.0	Outline Drawings	





Revision History

Date	Revision	Changes
09-April-2009	1	First release

Information furnished is believed to be accurate and reliable. However, HengDa Microwave assumes no responsibility for the consequences of use of such information nor for any infringement of patents or other rights of third parties which may result from its use. No license is granted by implication or otherwise under any patent or patent rights of HengDa Microwave. Specifications mentioned in this publication are subject to change without notice. This publication supersedes and replaces all information previously supplied. HengDa Microwave products are not authorized for use as critical components in life support devices or systems without express written approval of HengDa Microwave.

© 2002 Xi'an HengDa Microwave Technology Development Company - All rights reserved

Email: market@hdmicrowave.com

www.hdmicrowave.com